



سافيد
SAFID

ACOUSTIC LOUVERS





Introduction

There are many applications in the industry where large quantities of air must be drawn from the atmosphere. The equipment handling the air is frequently noisy and it is necessary to provide some attenuation between the air moving device and the exterior. We have already seen that this can be done with cylindrical or rectangular sound attenuators. However, in certain conditions it is more appropriate to use an acoustic louver which is a combination of a normal louver, as associated with air inlets to buildings, and attenuator.

They are frequently installed in the facades of buildings where they are architecturally acceptable and yet provide an adequate amount of attenuation to prevent creating unacceptably high noise levels outside. Effectively, an acoustic louver is a very short attenuator with a very large cross-sectional area, so it is appropriate where length is restricted but face area is not.

Description

Acoustic louvers provide a positive solution where acoustic performance is required from a weather louver. The acoustic performance for an acoustic louver is usually measured in terms of transmission loss. This enables a direct comparison to be made between the performance of the louver and a solid wall which it probably replaces. Acoustic louvers as well as attenuators are frequently used in mechanical equipment rooms where a requirement for ventilation exists.

They are available in either steel or aluminum construction with standard and high acoustic performance options. A non-acoustic version having a complementary appearance is available and a variety of colored finishes may be specified.



Description

Type SALS acoustic louvers provide a positive solution where acoustic performance is required from a weather louver. They are available in either steel or aluminum construction with 'single' or 'double bank' acoustic performance options. A non-acoustic version having a complementary appearance is available. A variety of coloured finishes may be specified.

Construction

Steel Construction

Casings are manufactured from galvanized sheet metal channels Ga.16 minimum. Galvanized louver blades are of aerodynamic section and are set at approx. 40° on 150mm pitches. Bird screens from 12x12x1mm galvanized wire mesh are fitted as standard to all types, except Type SALN when fitted with blanking plate.

Acoustic louver blades contain infill which complies with Class O Building Regulations. The infill has a glass cloth facing and is contained behind perforated metal; this dual protection prevents damage and fibre erosion up to 30 m/s airway velocity.

Aluminum Construction

Construction is generally as for steel types described above except that the casing and louver blades are made from mill finish aluminum alloy, type 1050-H14.

Alternative Construction

SALD

Type SALD; double bank acoustic louver comprising of two SALS type mounted back to back.

SALN

Type SALN; non-acoustic version with complementary appearance. Can be supplied with rear blanking plate to prevent air passage.

Dimensions

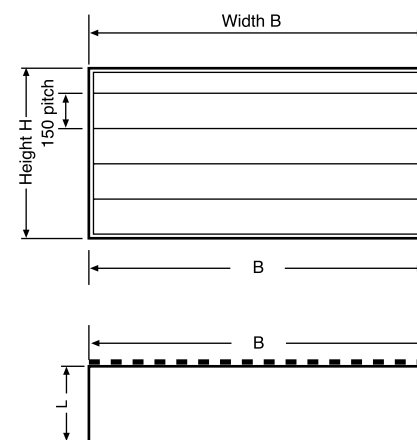

Dimensions in mm	Standard Sizes
W	300 to 1800 in increments of 150
H	450 to 2400 increments of 150

SALS, SALD AND SALN

Dimensions

SALS

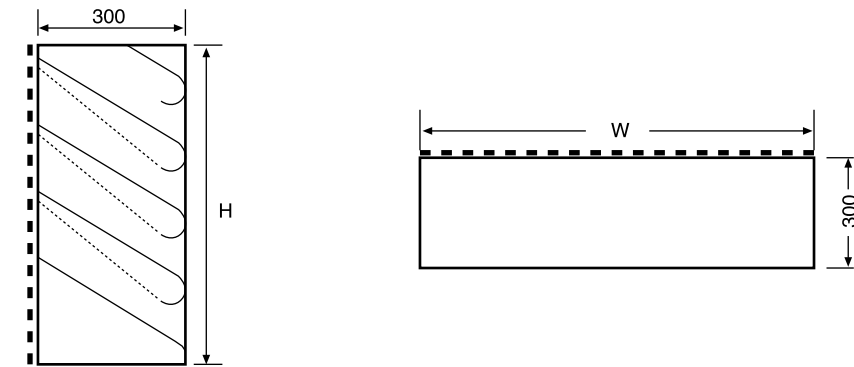

SALD

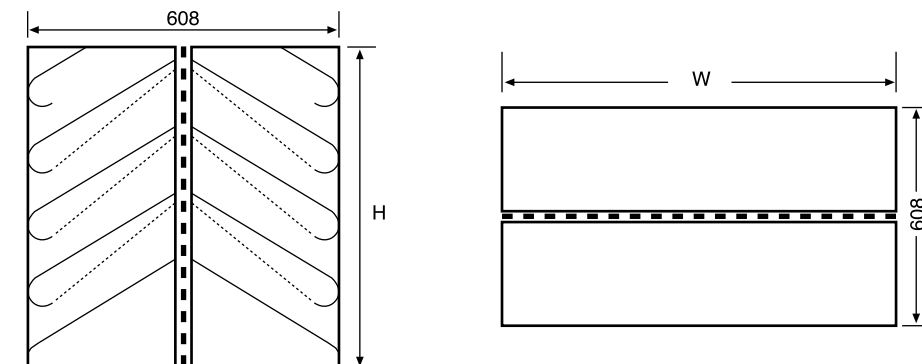

SALN

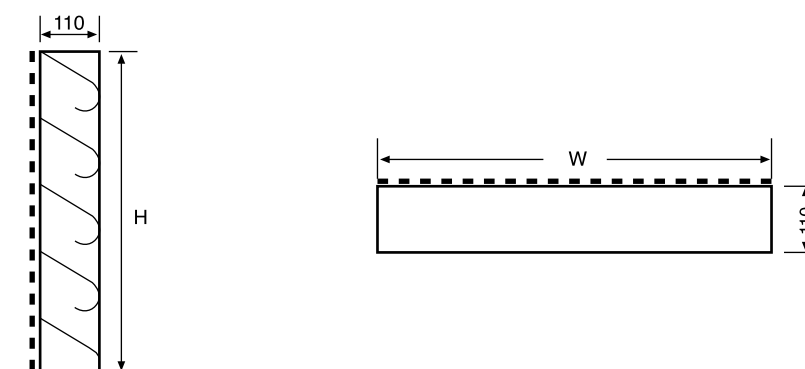

SALS, SALD AND SALN

Sectionalized Construction

Acoustic louvers are normally supplied in sections when either of the following dimensions is exceeded:

B = 1800 mm H = 2400 mm

Where louvers are in sections in both width and height, a 50x50x3 galvanized vertical box section frame is supplied to couple together adjacent sections. The weight of the upper section is borne by the coupling frame and not by the lower louver. Coupling frames are concealed behind a cover plate of material and finish to complement the louver.

The combinations illustrated on this page are available in louver Types SALS, SALD and SALN.

1. Split on width only.
2. Split on width and height.
3. Split on height only.

The assembly of sectionalised louvers is on site, by others. SAFID will provide full details of louver configuration and assembly.

Optional Features

Louvers can be supplied with matching sheet metal architrave or rolled metal angle picture frame. These would be supplied loose and undrilled for site fixing by others.

Dimensions

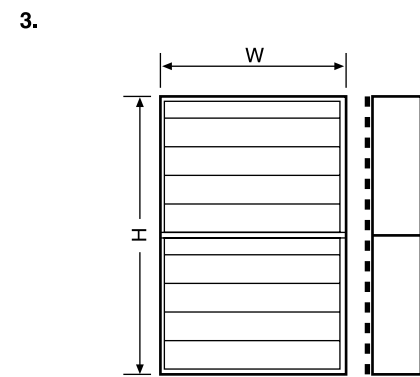
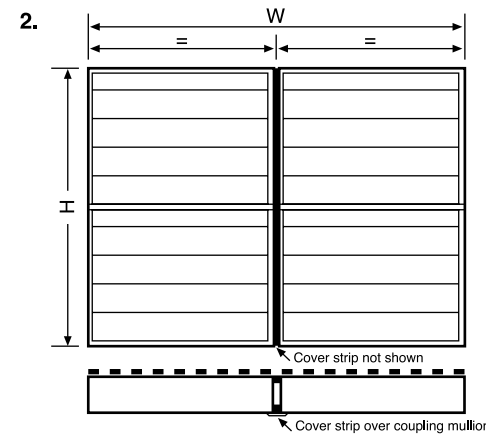
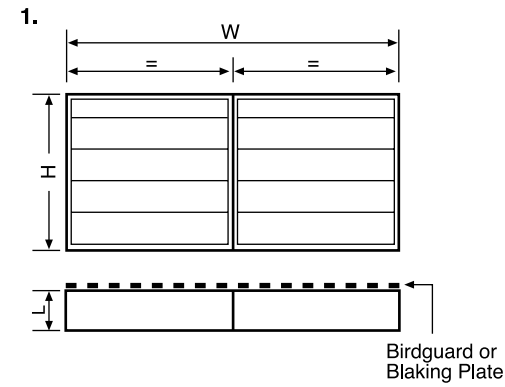

Installation

Type SALS, SALD, SALN

The vertical casing sides of the acoustic louvers are pre-slotted to facilitate fixing using a variety of acceptable methods. Where supplied, architraves and picture frames are supplied loose and undrilled.

On multisection units incorporating hollow section coupling frames, the frames are supplied drilled for easier site assembly. During fixing, the louvers should be set square and true in opening then wedged before fixing. Air gaps should be filled with a flexible mastic.

Installation and fixing items are not normally supplied; however, screws would be provided for use with our standard vertical box sections frames, where supplied.

Installation Details

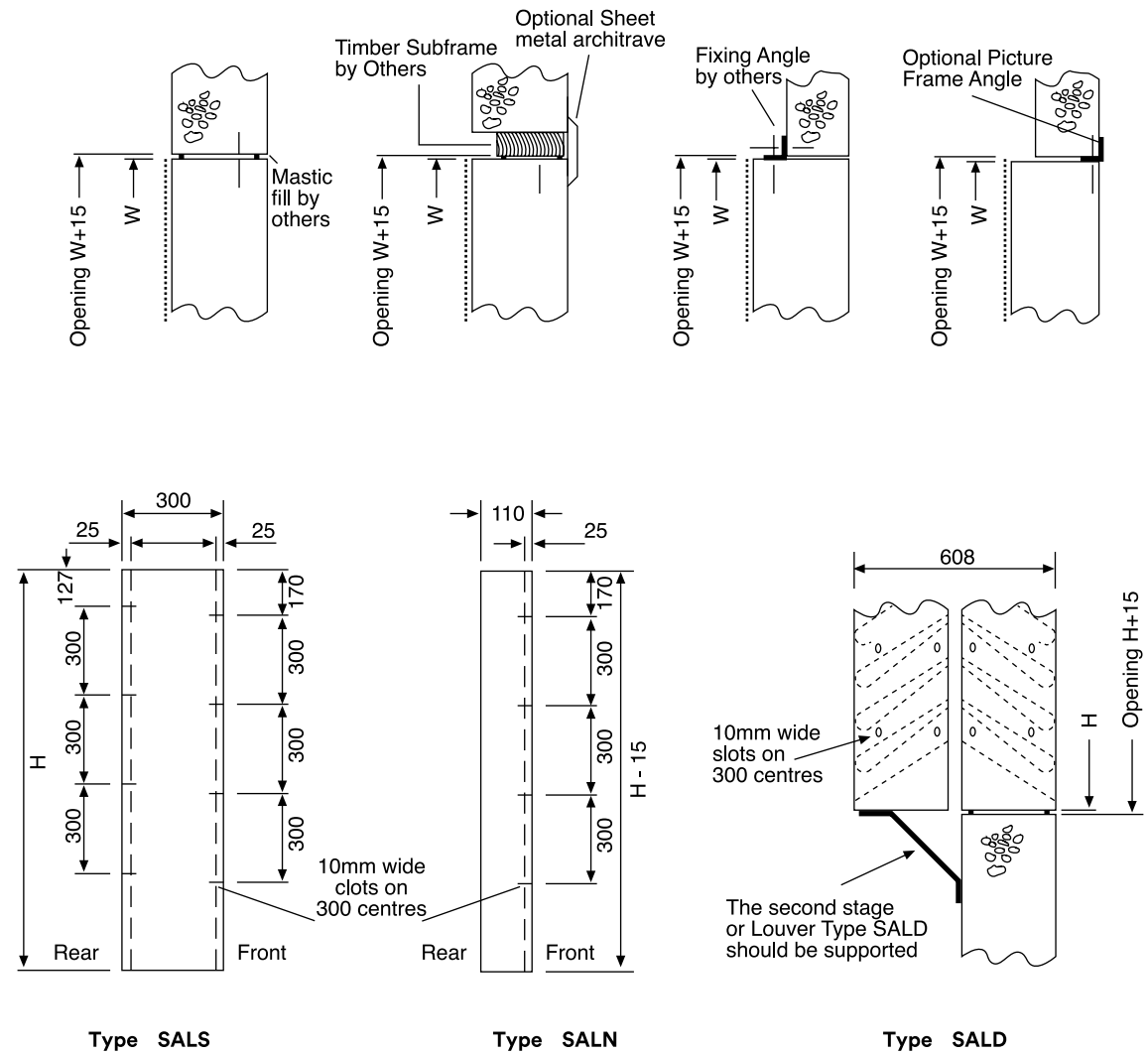

Louver Selection

The acoustic performance needed to meet a particular design noise requirement can be calculated from other technical sources. Table 1 indicates the acoustic performance available from standard and high performance acoustic louvers.

From Table 2, select a louver size at a face velocity that gives an acceptable pressure loss. Check that louver self-noise will not infringe upon the design noise criterion by reference to the Self Noise Index, SNI.

The SNI gives an approximation of regenerated noise from the louver due to air velocity. This is expressed as an NC value at 1 meter, 3 meters and 10 meters from the louver face. The louver selected should have an SNI at least 5 NC below the design noise criterion.

Nomenclature

L in mm : Length (in direction of airflow)

W in mm: Width

H in mm: Height

V in l/s: Volume Flow Rate

V_f in m/s: Face Velocity based on $V \div (W \times H \times 1000)$

Δp in Pa: Pressure Loss

f_m in Hz: Octave Center Frequency

SRI in dB: Sound Reduction Index

SNI: Self Noise Index (equivalent to NC sound pressure level curve at free field distance shown)

Example

a) SRI Required @ f_m

63	125	250	500	1k	2k	4k	8k	Hz
3	5	7	11	14	16	10	8	dB

b) Design Noise Criterion = NC50 at 3 meters from opening.

c) Volume Flow Rate, V = 12000 l/s.

d) Maximum Required Pressure Loss, Δp=50Pa

e) Maximum Required Height, H = 1200mm.

1) From Table 1, a standard performance Type SALS louver would meet the required acoustic performance.

2) From Table 2, the maximum permissible face velocity, for Δp = 50 Pa, is 2.8 m/s.

3) From Table 2, the maximum permissible face velocity, v_f for an SNI of 50 minus 5 at 3m, is 4.9 m/s.

4) Size the louver at the limiting velocity of 2.8 m/s.

$$\begin{aligned} \text{Required Louver Ara (m}^2\text{)} &= V \div (v_f \times 1000) \\ &= 12000 \div (2.8 \times 1000) \\ &= 4.290 \end{aligned}$$

$$\begin{aligned} \text{Width (W Required)} &= 4.290 \div H \text{ (in meters)} \\ &= 4.290 \div 1.2 \\ &= 3.575 \text{ meters} \\ &= 3575 \text{ mm} \end{aligned}$$

Louver Selection:
Type SALS; W x H, 3575 x 1200
(Specify materials and Finish)

Acoustic Performance

Acoustic louver performance has been derived from tests based on BS 2750. The test work was carried out using a reverberant room technique. Measurements with and without the test piece were compared to produce the 'Sound Reduction Index' (also known as 'Transmission Loss') of both the 'single bank' performance SALS acoustic louver and the 'double bank' performance version SALD.

The term 'Noise Reduction' is sometimes encountered. This refers to free field measurements taken in close proximity to the louver face rather than in the reverberant receiving room described in BS 2750. This method tends to improve upon the Sound Reduction Index figures by 6 dB.

However, for most applications the 'Sound Reduction Index' data is the more appropriate, since for all practical purposes it may be used in the same way as the static insertion loss of a duct attenuator.

The aerodynamic profile of the acoustic louver blade ensures low pressure loss similar to conventional non-acoustic weather louvers of higher free area. The percentage free area varies with louver height, with the smaller louvers most affected by the restriction of the top and bottom dummy sections.

Weights

Louver Type	Approximate Weights
SALSS	48kg/m ² face area
SALSA	35kg/m ² face area
SALD	as SALSS or SALSA x 2
SALN	as SALSS or SALSA x 0.5

Table 1: Sound Reduction Index (SRI in dB)

Louver Type	Octave Center Frequency f ^m in Hz							
	63	125	250	500	1k	2k	4k	8k
SALS	5	5	7	11	15	18	13	13
SALD	8	9	12	19	28	30	23	22

Pressure Loss and Regenerated Noise

Table 2:
Type SALS (ducted from atmosphere)

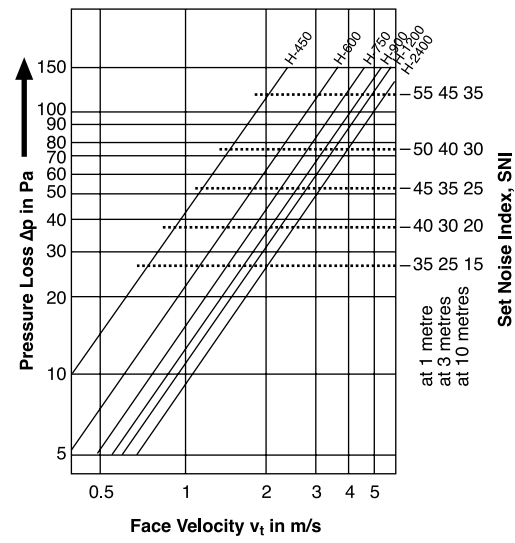

Type SALD (ducted from atmosphere)

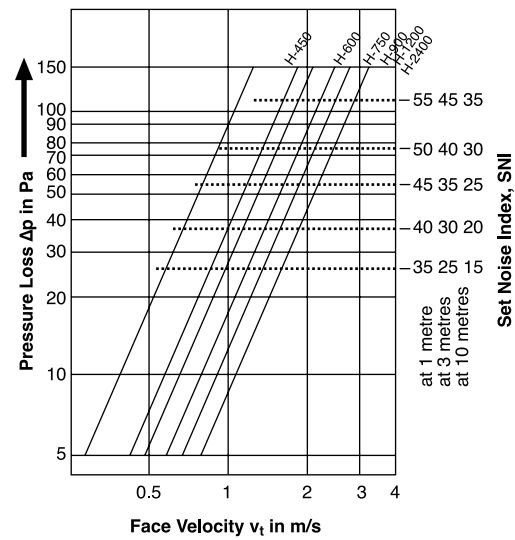

Order Details

Specifications Text

Type SALS acoustic louver constructed from either galvanized sheet steel or natural mill aluminum with finish as specified. 1.5 mm thick channel casing incorporates aerodynamic acoustic blades containing erosion protected Class O infill covered by perforated sheet metal. Casing sides are pre-slotted for fixing into a prepared opening.

Ordering

Product Code: SAL D A 4000 1800

Type

Type Suffix:

S - Single Bank

D - Double Bank

N - Non Acoustic

Material:

S - Galvanized Steel

A - Natural Aluminum

W (width, mm)

H (height, mm)

